

# How to Measure Custom Pressure Washer Covers - Design 7

## Measurement Instruction

- ✓ Give exact measurement from edge to edge.
- ✓ We add 1" to 2" leeway on the given width/depth for easy pull-in and pull-out.
- ✓ The height dimensions will remain same as provided by you.
- ✓ All measurements will be done in inches.

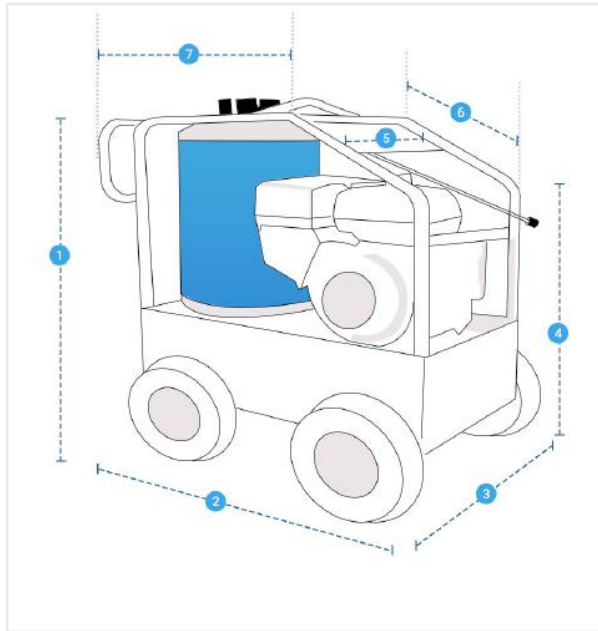

### Measurement (Inches)

- |                              |                      |                          |                      |
|------------------------------|----------------------|--------------------------|----------------------|
| 1. Back Height               | <input type="text"/> | 2. Depth                 | <input type="text"/> |
| 3. Bottom Width              | <input type="text"/> | 4. Front Height          | <input type="text"/> |
| 5. Top Width                 | <input type="text"/> | 6. Slant Distance at Top | <input type="text"/> |
| 7. Straight Length till Back | <input type="text"/> |                          |                      |

**1. Back Height:**  
Back Height of Pressure Washer

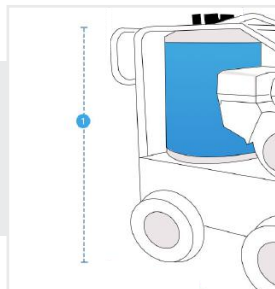

**2. Depth:**  
Depth of Pressure Washer

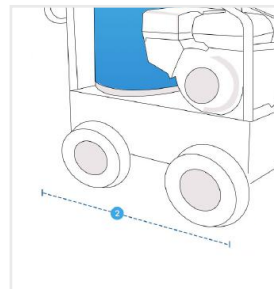

**3. Bottom Width:**  
Bottom Width of Pressure Washer

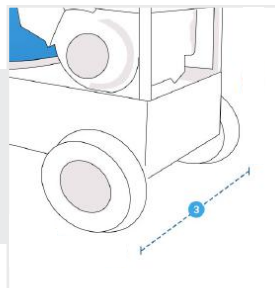

**4. Front Height:**  
Front Height of Pressure Washer

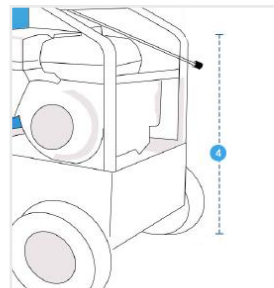

We encourage you to upload the image of the article you need the cover for - this helps our team ensure covers are designed keeping your requirements in mind.

## How to Measure Custom Pressure Washer Covers - Design 7

### Measurement Instruction

- ✓ Give exact measurement from edge to edge.
- ✓ We add 1" to 2" leeway on the given width/depth for easy pull-in and pull-out.
- ✓ The height dimensions will remain same as provided by you.
- ✓ All measurements will be done in inches.

#### 5. Top Width:

Top Width of Pressure Washer

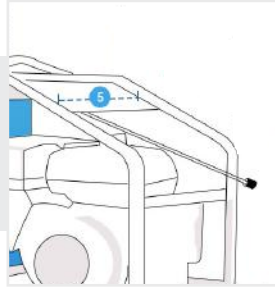

#### 6. Slant Distance at Top

Slant Distance at Top of Pressure Washer

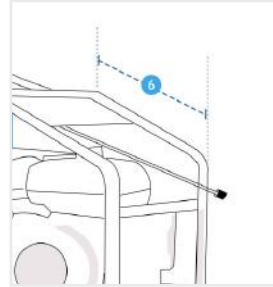

#### 7. Straight Length till Back:

Straight Length till Back of Pressure Washer

