

How to Measure Custom Covers - Design 6

Measurement Instruction

- ✓ Give exact measurement from edge to edge.
- ✓ "We add upto 2" leeway on the given width/depth for easy pull-in and pull-out."
- ✓ The height dimensions will remain same as provided by you.

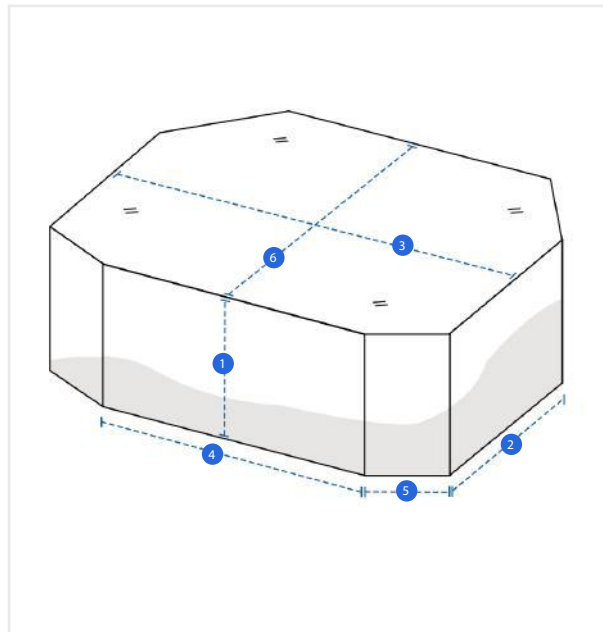

Measurement (Inches)

1. Height	<input type="text"/>	2. Depth #1	<input type="text"/>
3. Width #1	<input type="text"/>	4. Width #2	<input type="text"/>
5. Corner Depth	<input type="text"/>	6. Depth #2	<input type="text"/>

1. Height:
Height of the Product

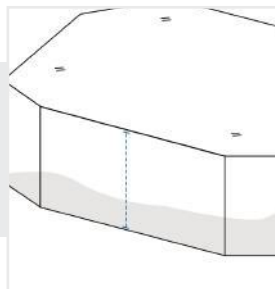

2. Depth #1:
Depth #1 of the Product

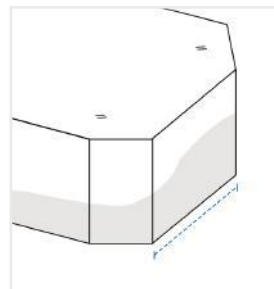

3. Width #1:
Width #1 of the Product

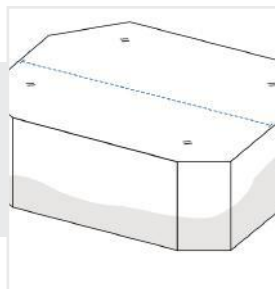

4. Width #2:
Width #2 of the Product

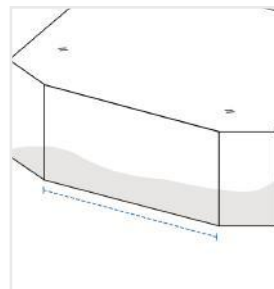

5. Corner Depth:
Corner Depth of the Product

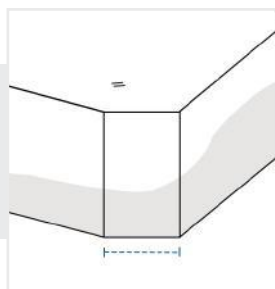

6. Depth #2:
Depth #2 of the Product

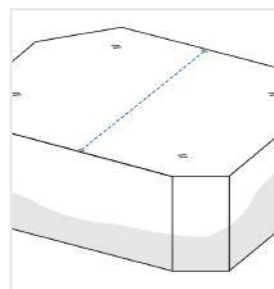

We encourage you to upload the image of the article you need the cover for - this helps our team ensure covers are designed keeping your requirements in mind.