

How to Measure Custom Concession Display Cover – Design 1

Measurement Instruction

- ✓ Give exact measurement from edge to edge.
- ✓ We add 1" to 2" leeway on the given width/depth for easy pull-in and pull-out.
- ✓ The height dimensions will remain same as provided by you.

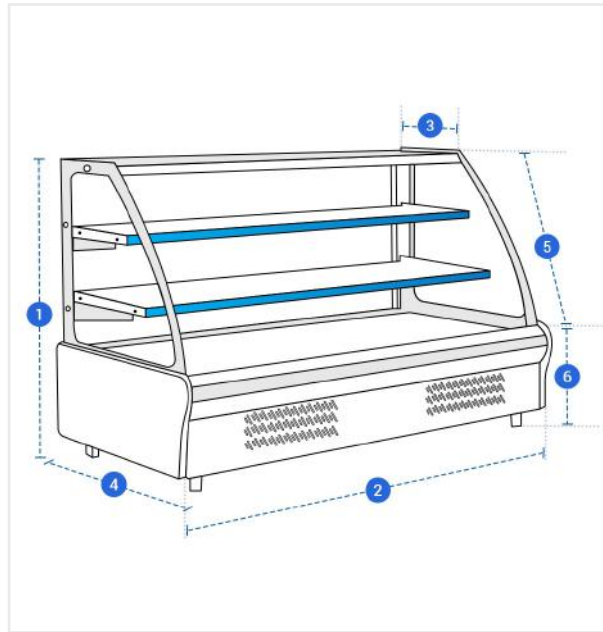

Measurement (Inches)

1. Back Height	<input type="text"/>	2. Width	<input type="text"/>
3. Upper Depth	<input type="text"/>	4. Bottom Depth	<input type="text"/>
5. Slant Height	<input type="text"/>	6. Front Height	<input type="text"/>

1. Back Height:

Back Height of the Custom Concession Display

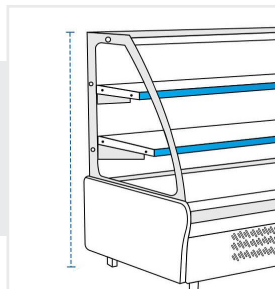

2. Width:

Width of the Custom Concession Display

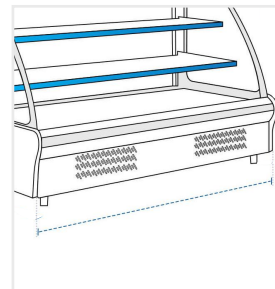

3. Upper Depth:

Upper Depth of the Custom Concession Display

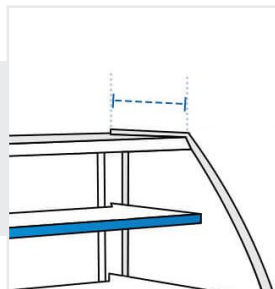

4. Bottom Depth:

Bottom Depth of the Custom Concession Display

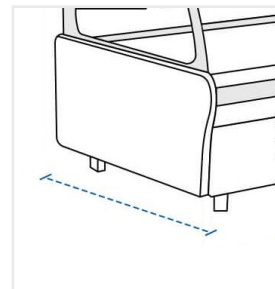

5. Slant Height:

Slant Height of the Custom Concession Display

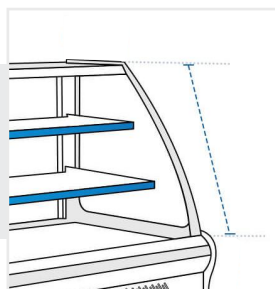

6. Front Height:

Front Height of the Custom Concession Display

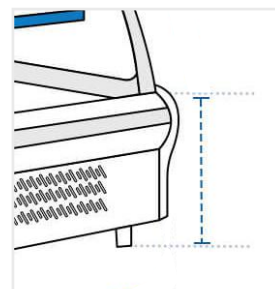

We encourage you to upload the image of the article you need the cover for - this helps our team ensure covers are designed keeping your requirements in mind.