

## How to Measure 70-73 inch TV Covers

### Measurement Instruction

- ✓ Give exact measurement from edge to edge.
- ✓ We add 1" to 2" leeway on the given width/depth for easy pull-in and pull-out.
- ✓ The height dimensions will remain same as provided by you.

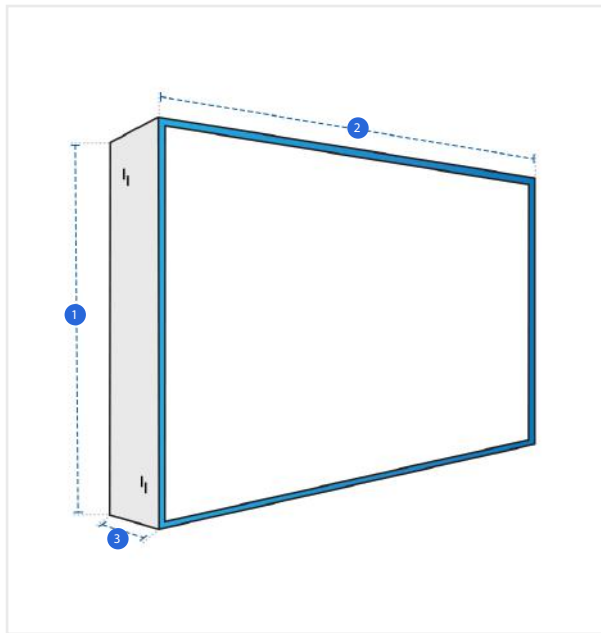

### Measurement (Inches)

1. Height

2. Width

3. Depth

**1. Height:**  
Height of the TV

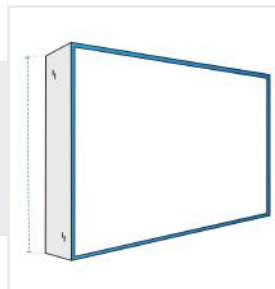

**2. Width:**  
Width of the TV

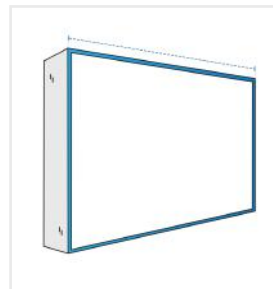

**3. Depth:**  
Depth of the TV

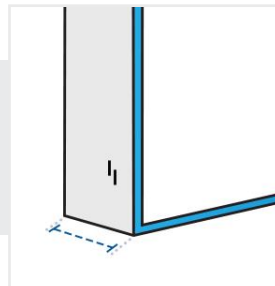

We encourage you to upload the image of the article you need the cover for - this helps our team ensure covers are designed keeping your requirements in mind.